

Article number: 12705000100120

Description: KLEE-coil 705 000 100.120
M10 Unhardened, zinc-pl. & chr. yellow

Measures

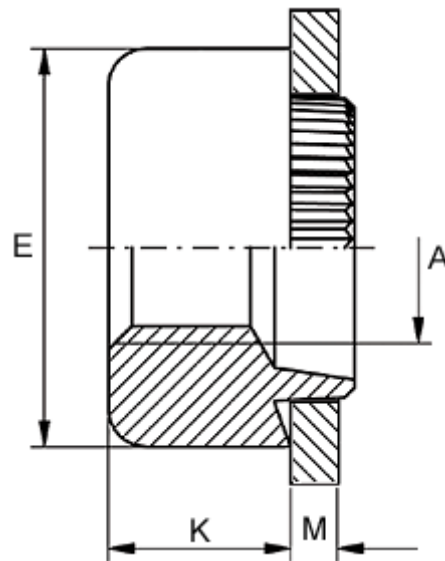

Female thread A	= M10
Height K	= 8.0
Outer diameter E	= 19.0
Plate thickness	= 1.1 to 1.3
Recommended bore diameter for extreme load	= 15.0
Recommended bore diameter for normal use	= 16.0